

Manual

SRM – High Performance Ergometer



Table of Contents

1. General preparation for performance diagnostics	3
2. Connecting the Ergometer (Ports).....	3
3. Installation and Landing Page of the SRM Ergometer Software	3
4. Settings SRM Ergometer Software	4
Network	4
Network settings in windows	5
Network settings in OSX	11
Chart	14
Test	15
Ergometer	16
5. Athletes.....	19
6. Ergometer preparation for testing & training	20
Settings the Crank length	20
Mechanical adjustment & positioning of the athlete.....	22
Fly masses.....	23
Bike fitting.....	26
Rohloff gear check.....	27
7. PowerControl Ergometer	28
Main menu	28
Sensor Pairing.....	29
Control test with PowerControl keys.....	29
8. Workouts.....	31
9. Test	31
Warm-up.....	32
Start and Stop performance diagnostics	32
Next steps	33
10. Activities	34
11. File Transfer.....	34
12. Service.....	35

1. General preparation for performance diagnostics

- Power-on spiroergometry (30min before beginning of test)
- Preparation of other diagnostic devices before starting of a test (Lactate analysis, etc.)
- Power-on ergometer's power supply
- Control of the room temperature (optimum range: 18 – 24°C), the relative room air humidity (optimum range: 30 – 60%) and the barometric pressure
- Check position of ventilator

2. Connecting the Ergometer (Ports)



1- Power Supply

2- Serial Port

The serial port is only for the external control by CPX/CPET, EKG or other medical devices by the so called "ergoline" protocol. The idea is to specify the protocols in the CPX/CPET or EKG software to be independent of the SRM Ergometer software.

Please connect the SRM ergometer via the serial port and the USB-to-Serial Adapter to the controlling computer.

Please note: If you like to control the protocol by an external device don't start the performance diagnostics in the SRM ergometer software. The SRM ergometer software is dominant.

3- Torque Analysis

4- Ethernet Ergometer

3. Installation and Landing Page of the SRM Ergometer Software

Please install the SRM ergometer software first on your controlling computer.

It's possible to choose one of the shown options directly. But before starting with the test procedure we recommend to check the settings first.

Please start pedaling and check the connection indicator on the lower left corner of the screen: This indicator should be green. If the indicator is red colored the network is not connected. Please check the settings again.



Landing page of the SRM ergometer software

4. Settings SRM Ergometer Software

Network

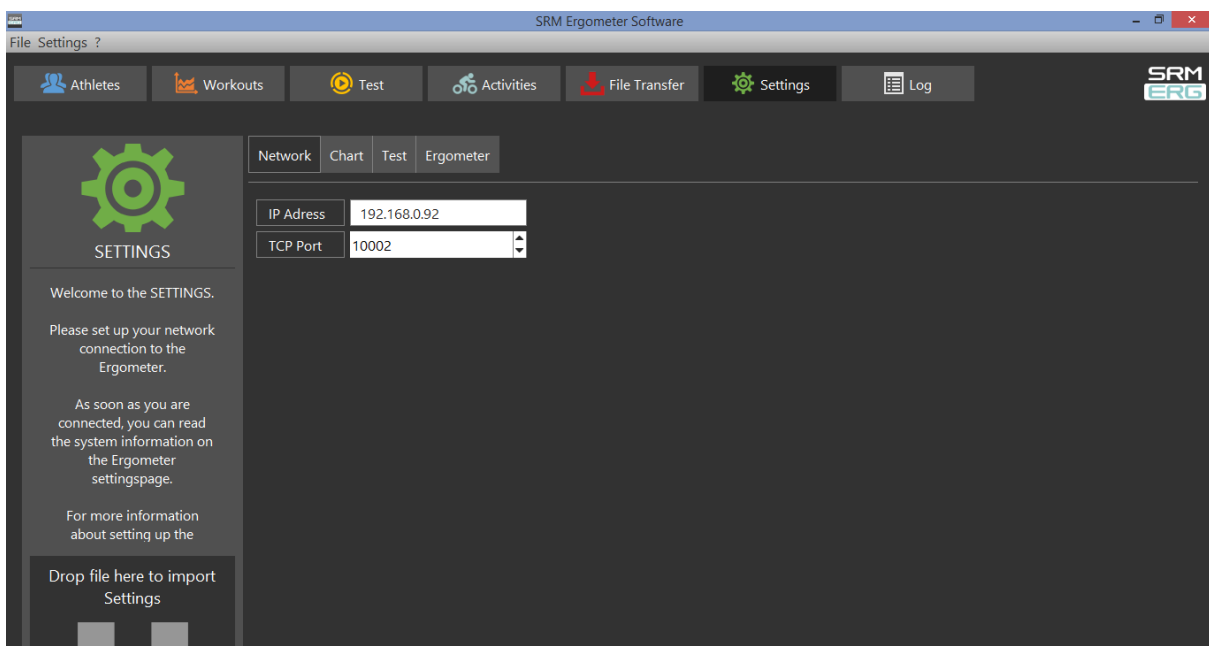

Settings Network: The default IP addresses for the Ergometer is 192.168.092 and the TCP port is 10002. both systems are IP address and TCP Port

The default IP addresses for both systems are:

- Ergometer Software: 192.168.092
- Torque Box Software: 192.168.091

Network settings in windows

Choose a free and valid IP address (192.168.0.x) for your computer in the same sub network as you did it for the SRM Ethernet Torque Analysis Box (To install the Torque Analysis Box see the manual of the Torque Analysis).

Please insert different IP addresses for the Ergometer and the Torque Box. We recommend to change just the last two numbers of the IP addresses (e.g. for the Ergometer 192.168.0.89 and for the Torque Box 192.168.0.90). Otherwise there will be a conflict of the IP addresses.

Please note the following installation sequence:

1. Network and Internet

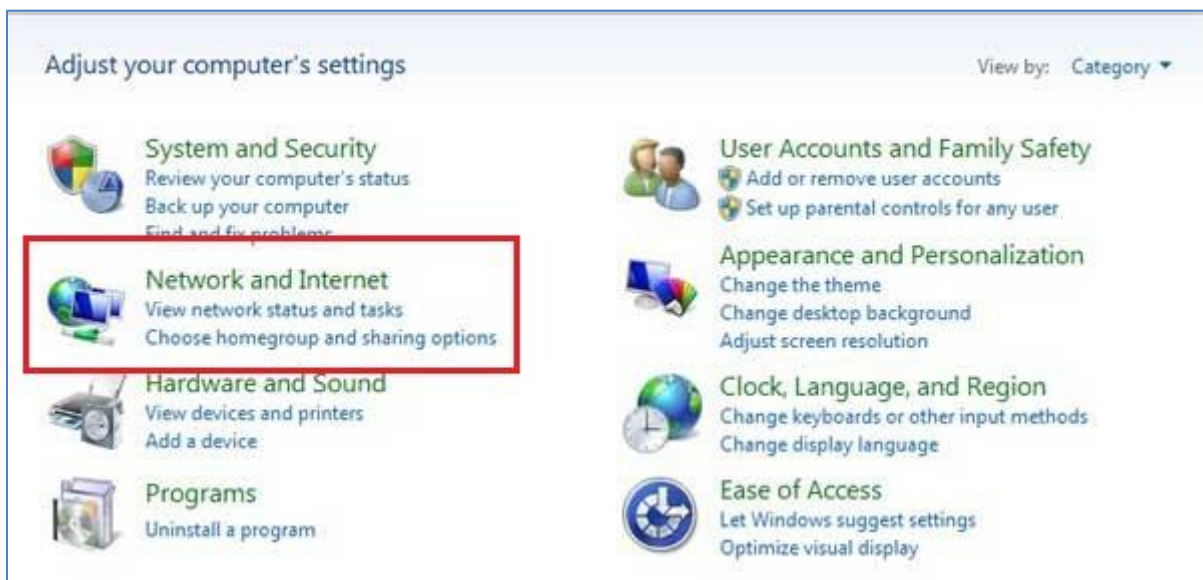

Press Windows "Start" button, open the "Control Panel" and click on "Network and Internet"

2. Network and Sharing Center



Select "Network and Sharing Center"

3. View Network Connections

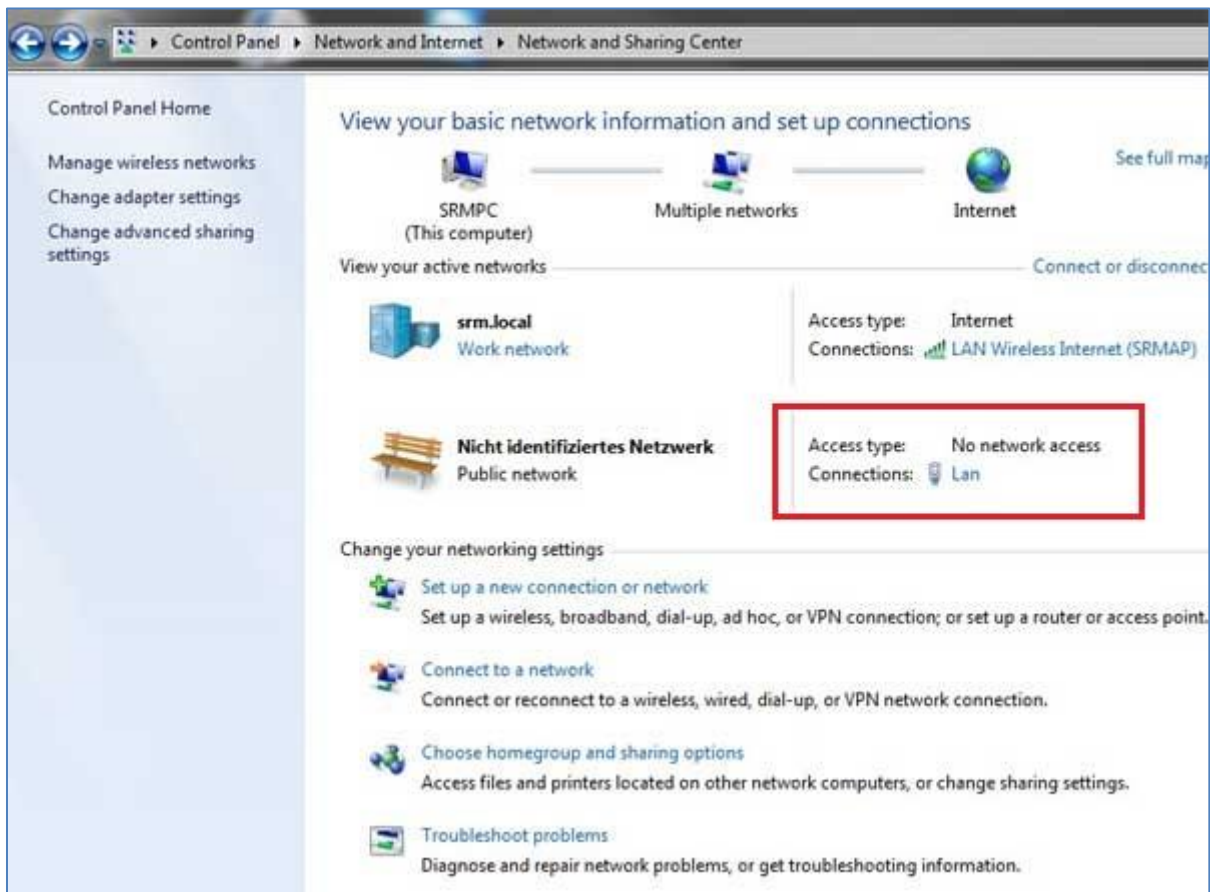

Click on the connection you need to change (i.e. LAN)

4. Properties

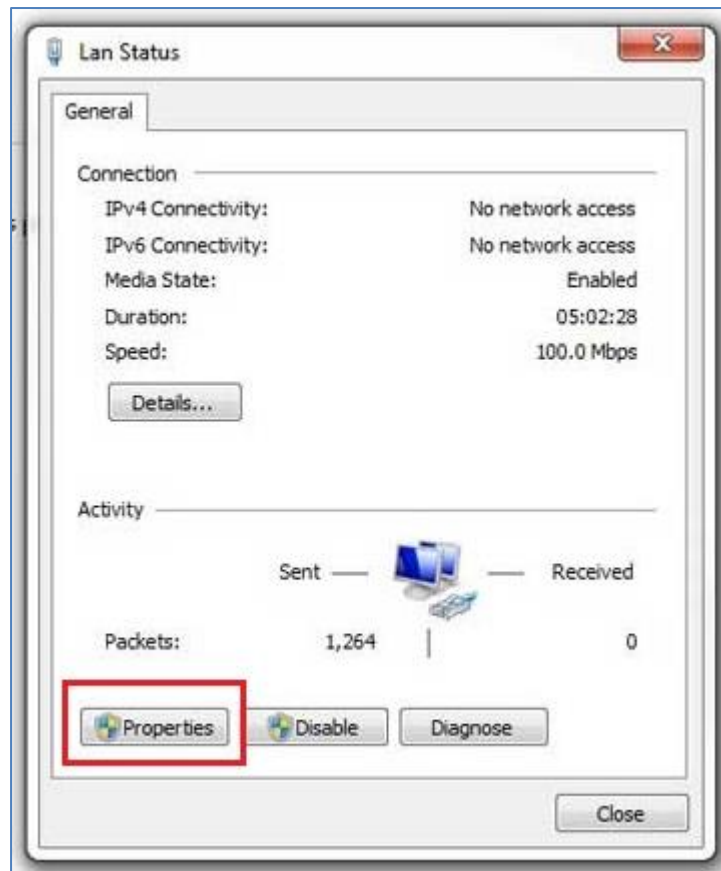

Open "Properties"

5. Internet Protocol Version 4 (TCP/IPv4)

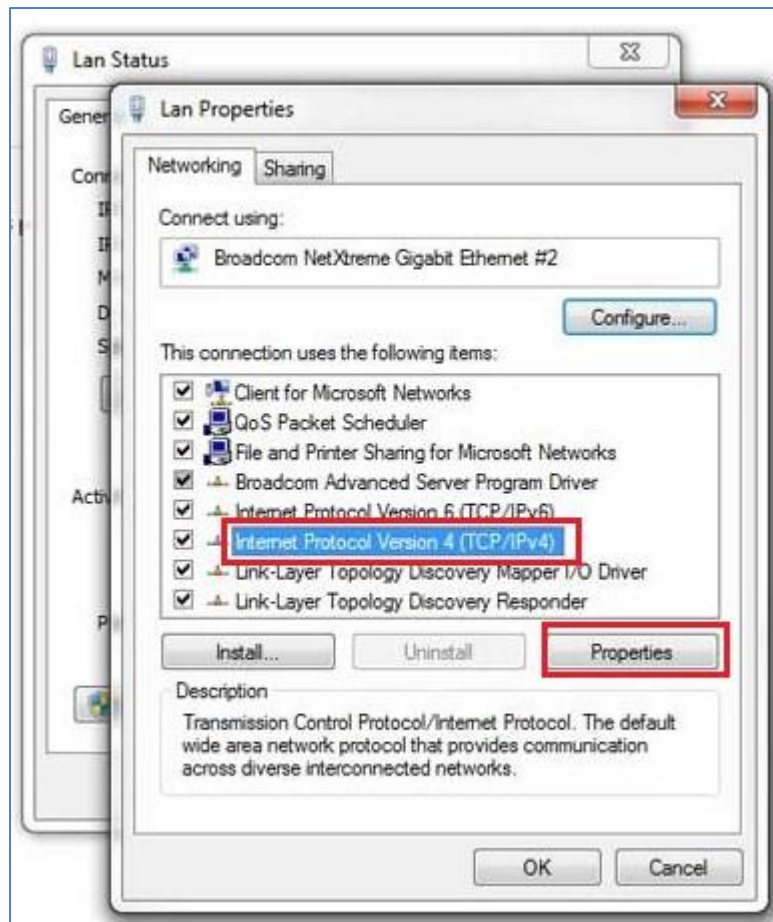

Double click on "Internet Protocol Version 4 (TCP/IPV4)"

6. Use the following IP address

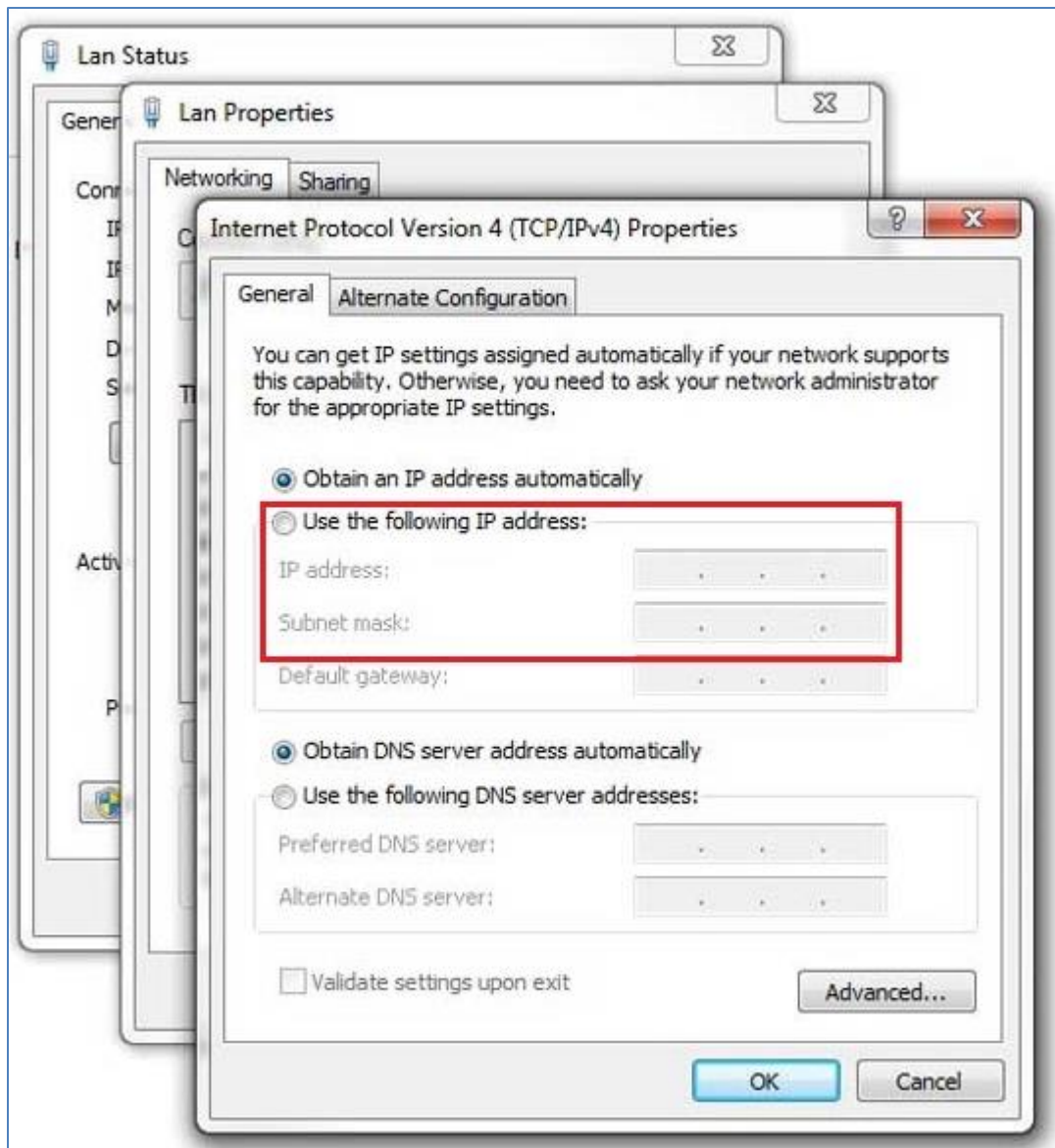

Activate "Use the following IP address"

7. IP address: 192.168.0.89

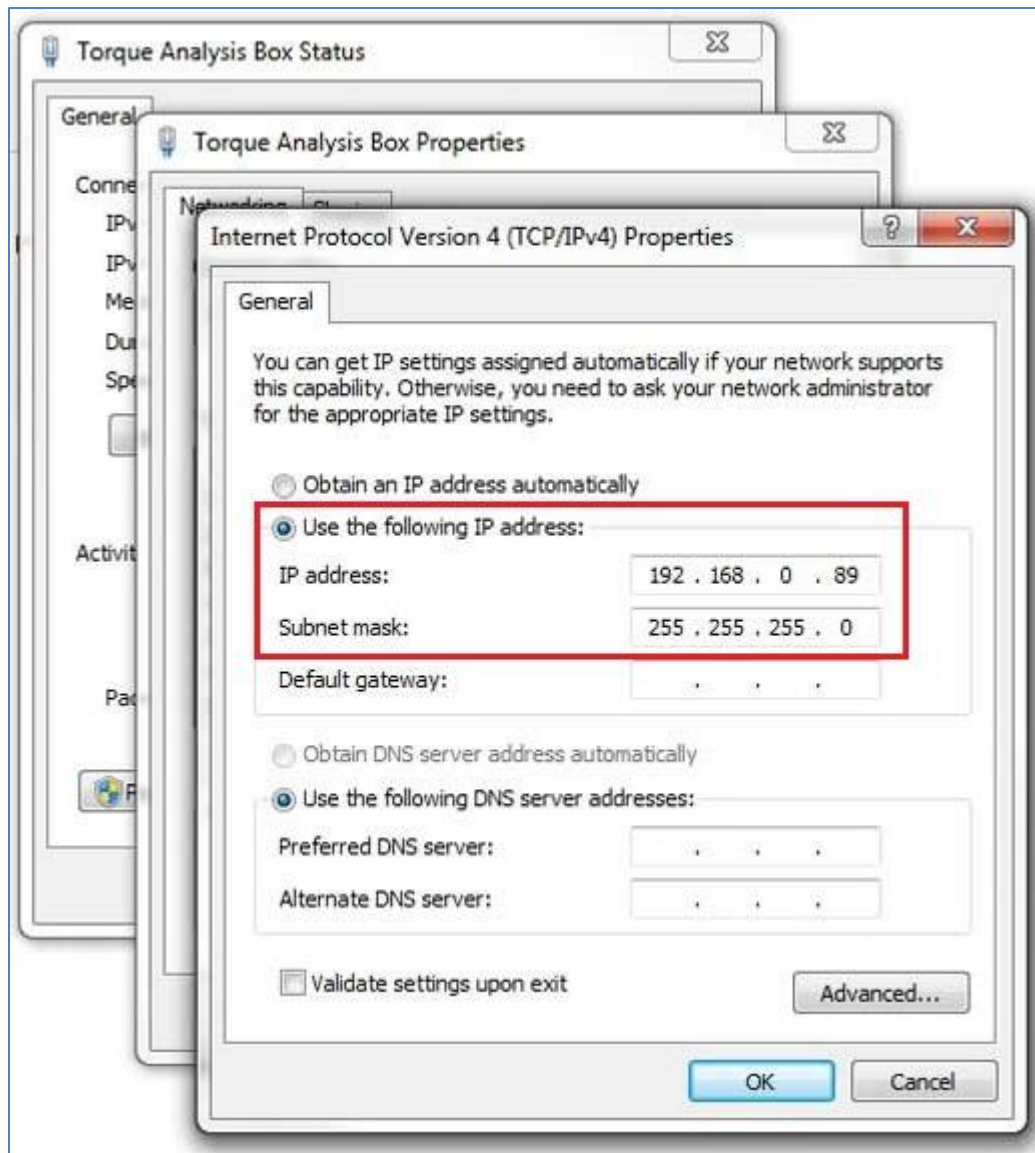

Insert the chosen IP address, the "Subnet mask" will be added automatically

Please start the ergometer software again, start pedaling and check the connection indicator on the lower left corner of the screen: this indicator should be green. If not go to log tab and check the messages and the settings again.

Network settings in OSX

If you are using Apple OSX: Launch „System Preferences“ from the Apple menu (or Spotlight), click on the „Network“ icon in the lower right, click on the „Advanced“ button, in the pulldown menu next to „Configure Ipv4“ select „Manually“ and insert the chosen IP address.

1. System Preferences

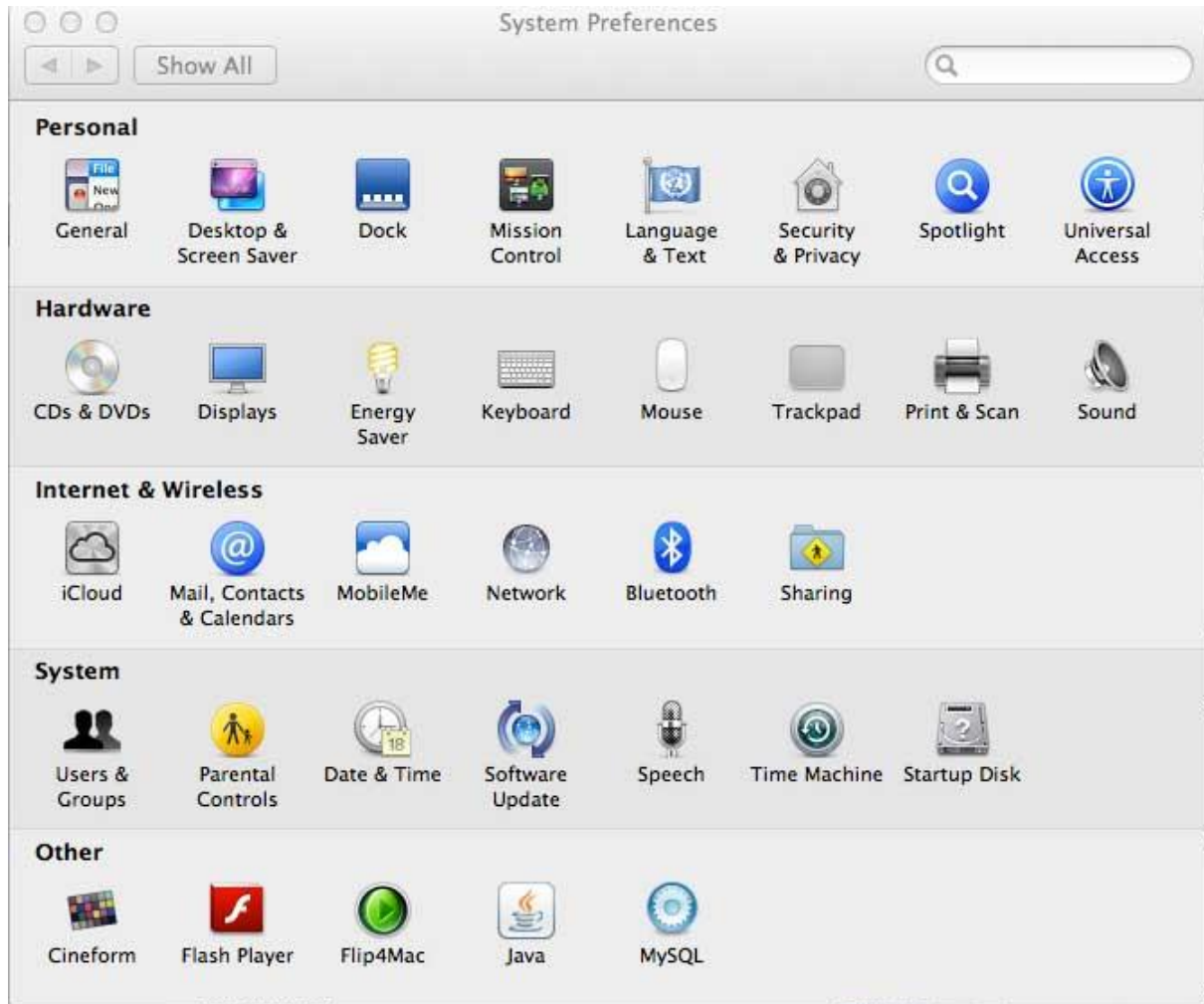

2. Network



3. Set the IP Address under Ethernet



Please start the ergometer software again, start pedaling and check the connection indicator on the lower left corner of the screen: this indicator should be green. If not go to log tab and check the messages and the settings again.

Chart

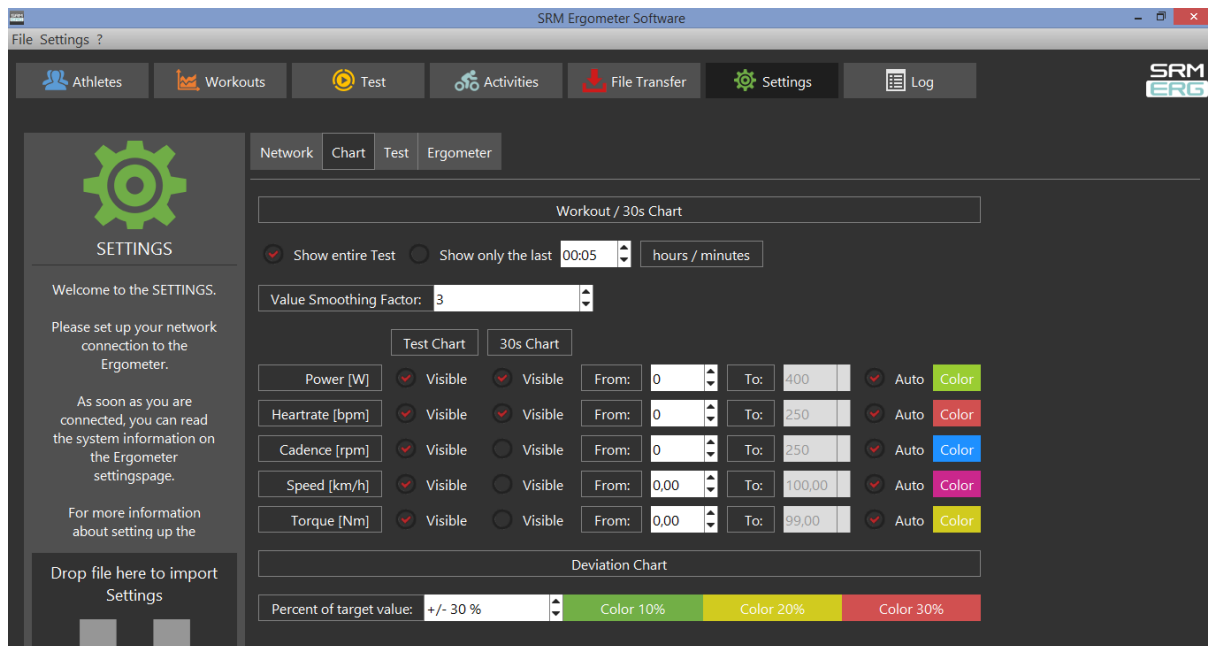

In this menu you can set the scaling of the graphs and the length of the displayed segments.

By selection of *Show entire Test* you will be shown the entire test on the monitor. By clicking on "Show only the last...minutes", you will only be shown the time period you entered before.

In the lower part of the window please specify by clicking on *Visible*, if you want to see the values *Power*, *Heart rate*, *Cadence* and/or *Speed*. Under *From / To*, you can define the range, in which the values will be shown. *Distance* gives you the difference of the chosen range.

Test Chart / 30s Chart

The settings of Test Chart and 30s Chart are able to configure individually.

Deviation Chart

Indicates the deviation of the cadence at the hyperbolic mode or the deviation of the performance at the isokinetic mode. To use this skill it is necessary to drop data into the workout table.

(For example: Power 100W / Cadence 50rpm / Choose Control by Power)

Test

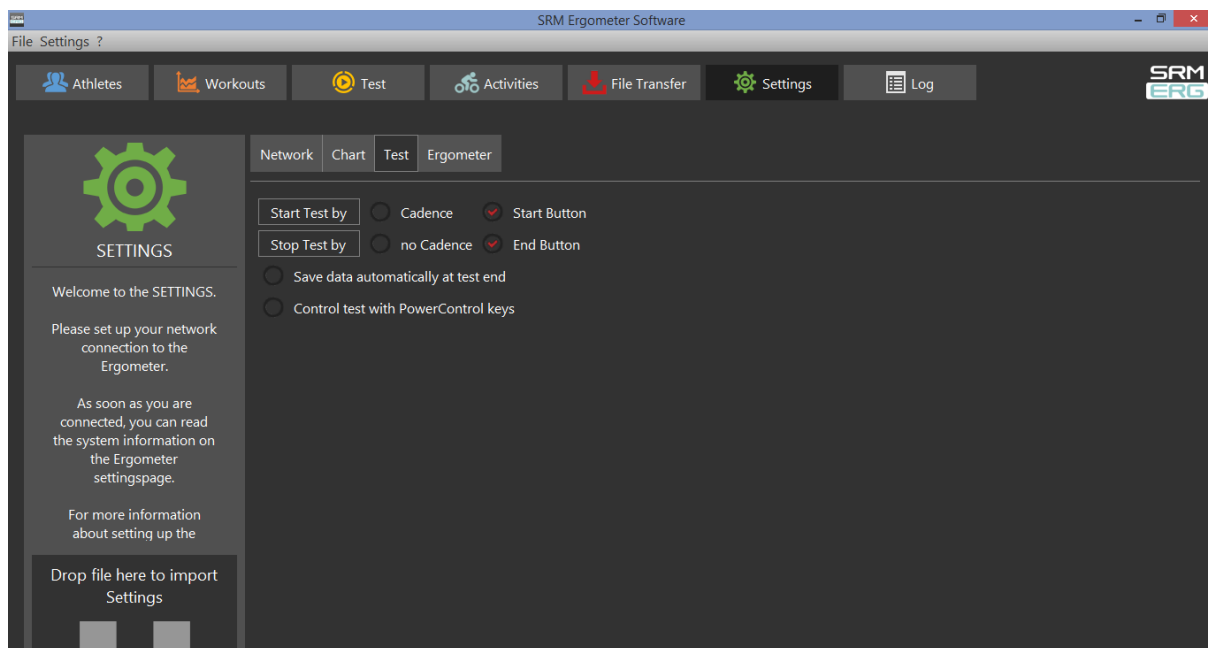

Start Test by

Under the button *Start Test by* you can decide if the test (or training session) will be started by reaching a specific cadence or by clicking the *Start Button*.

Starting by cadence: Start pedaling is displayed on the test interface.

Stop Test by

Under *Stop Test by* you can decide if the test will end automatically when there is no more cadence to be measured or by manually clicking the *End Button*.

Save data automatically at test end

Here you can set an automatically storage of your data file on your computer.

Even when you click no, you will asked to save the data file by ending the test.

Control test with PowerControl keys

Here you have the possibility to start and stop the test (or the training session) with the keys of the PowerControl.

Keyboard Shortcuts

- PRO (short): Test Start
- SET (short): Test Pause
- PRO (long): Test Resume
- SET (long): Test Stop

Ergometer

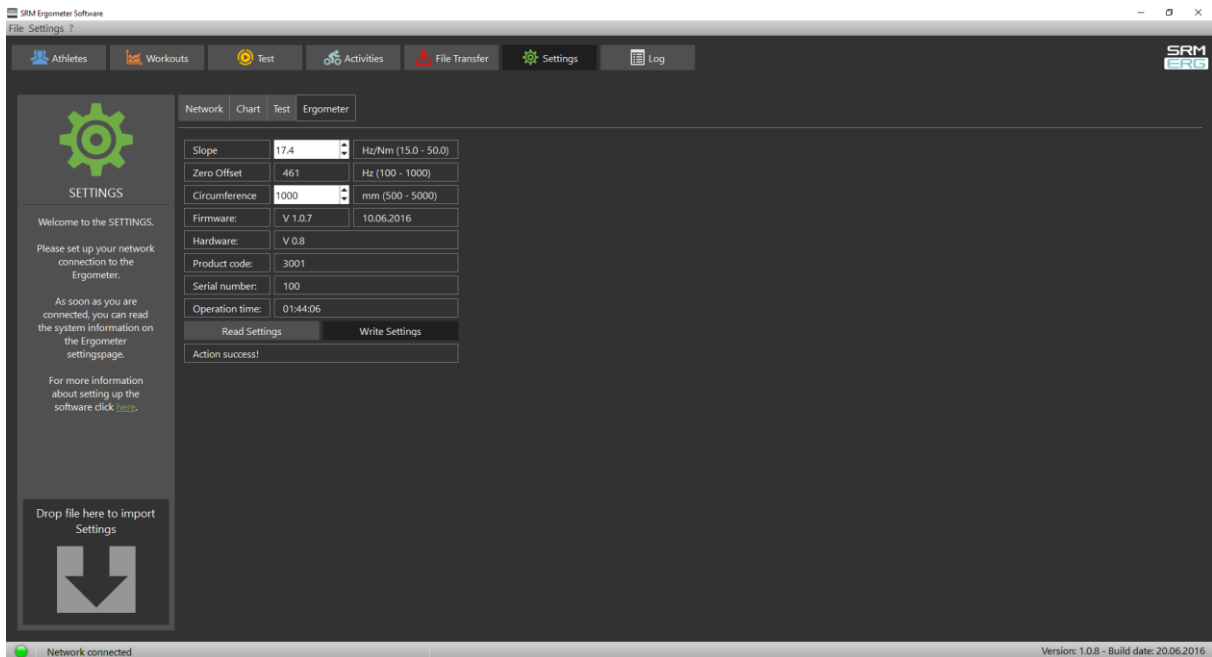

Slope

The slope in the ergometer software must correspond to the slope of the PowerMeter and the PowerControl.

We recommend to verify and control the slope of the PowerMeter before every test day.

You can find the correct PowerMeter slope on small labels located at

- the rear of the PowerMeter (s. PowerMeter picture),
- the front of the ergometer,
- the right crank arm,
- the handlebar.



PowerMeter incl. Slope and Serial Number

Zero Offset

The PowerMeter delivers a certain frequency which is proportional to the torque of the pedal force on the crank. If there is no load on the crank, the PowerMeter is sending a base frequency which must be communicated to the ergometer software and to the PowerControl as a reference value. This procedure is called zero offset calibration (offset adjustment).

The zero offset calibration has to be done before every new assembly of the PowerMeter and also before every measurement resp. every training on the Ergometer. A wrong zero offset calibration can result in an internal miscalculation of the power.

Please perform the zero offset calibration as it is described below:

- For a manual comparison, please turn the right unloaded crank clockwise to activate the PowerMeter.
- Wait a few seconds until the displayed value is stabilized.
- By pressing the **Read Settings** button, the zero offset will be displayed in the white background field.
- Press the **Write Settings** button, so that the zero offset will be saved.

(See also: Chapter 7 – PowerControl Ergometer – Zero offset calibration)

Circumference

The circumference only influence the displayed speed and is not important for the calculation of the data. We recommend to insert a value of 1.000 mm.

The following points show the current state of the ergometer. They are important for the identification and the service.

Firmware

The firmware can be updated if you drop the latest "SRM Firmware Image" file (*.sfi) in the box on the lower left corner of the screen: Drop file here to import.

The current firmware incl. date is displayed (e.g. V 1.1.8).

Hardware, Product Code, Serial Number

These informations are implemented from the SRM company to identify the ergometers specifications.

Operation time

The operation time will be documented in hh:mm:ss.

Read Settings

Read the current settings of the ergometer incl. the zero offset and the Slope.

Write Settings

Here it is possible to insert the slope and to save/to write it for the correct calculation of the data. Please note that the inserted slope must correspond to the slope of the PowerMeter.

5. Athletes

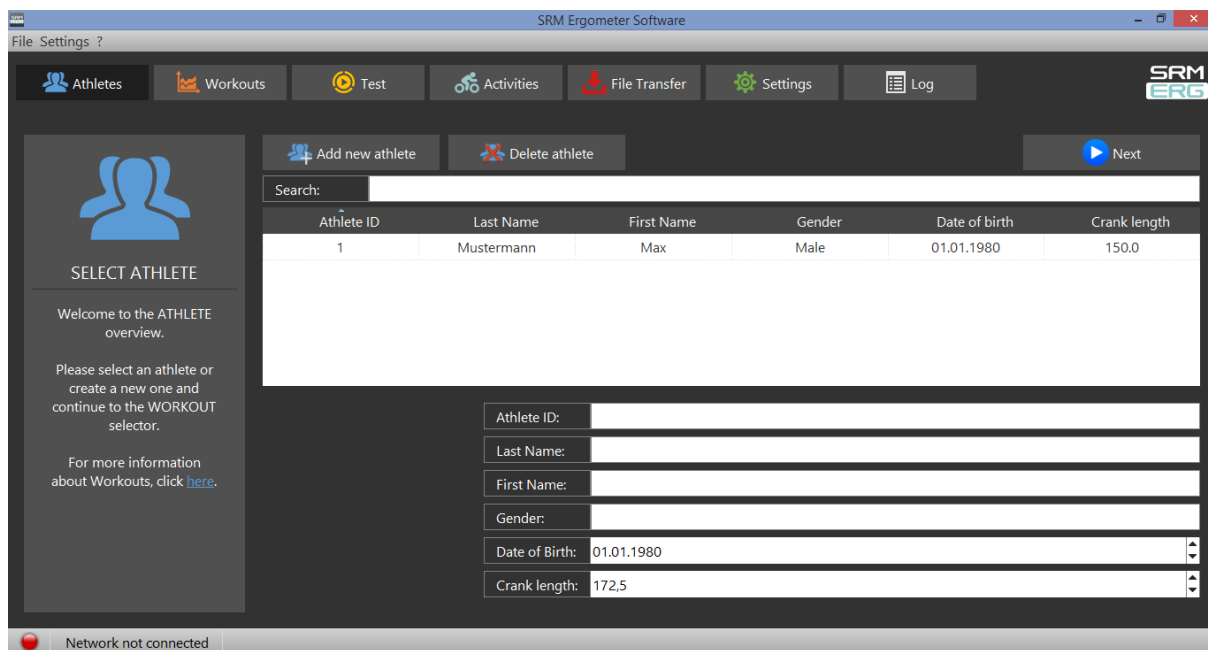

- Welcoming
- Clients prepare for test - put on the heart rate strap
- Choose the option "Add new athlete" to create a new profile or "Search" for an athlete you added before
- Documentation of personal data of client (name, height, weight, gender, date of birth, crank length)

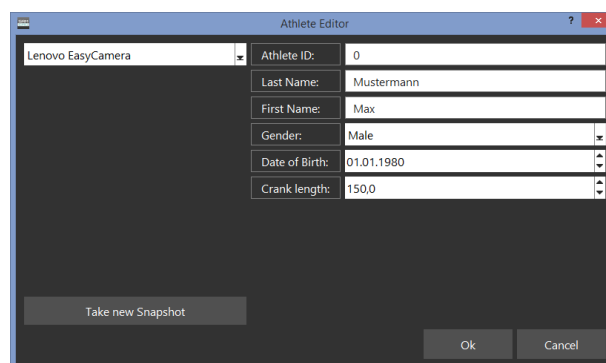

- Completion questionnaire / exclusion of liability
- Discussion of the data and test procedure
- Choose an "Athlete" or a "Workout" with the Next-Button. An information sign indicates if there is not chosen an Athlete/Workout.

6. Ergometer preparation for testing & training

Before every performance diagnostic or every training you should check the positioning of the athlete. The mechanical adjustment of the SRM – Ergometer allows the rider to find his individual positioning.

Settings the Crank length

First we recommend to mount the client's pedals and set-up the crank length as on client's bicycle.

The prolongable crank has round markings every 2.5 mm and every 10 mm a line. If the steel element of the crank is completely retracted in the aluminium crank the minimal length of the crank arm is 150 mm. If the crank arm is completely pulled out, the maximal length is 190 mm. Before changing the crank arm length you have to open both Allen screws.



After adjusting the right crank arm length, please tighten the Allen screws again with a maximal torque of 10 Nm so that they won't come loose while you ride the Ergometer. Make also sure that the screws are situated with a distance of a 2.5 mm. This can be determined when the fixing spring (situated between the Allen screws) locks into the holes of the steel element of the crank. Please do never remove or adjust the fixing spring.

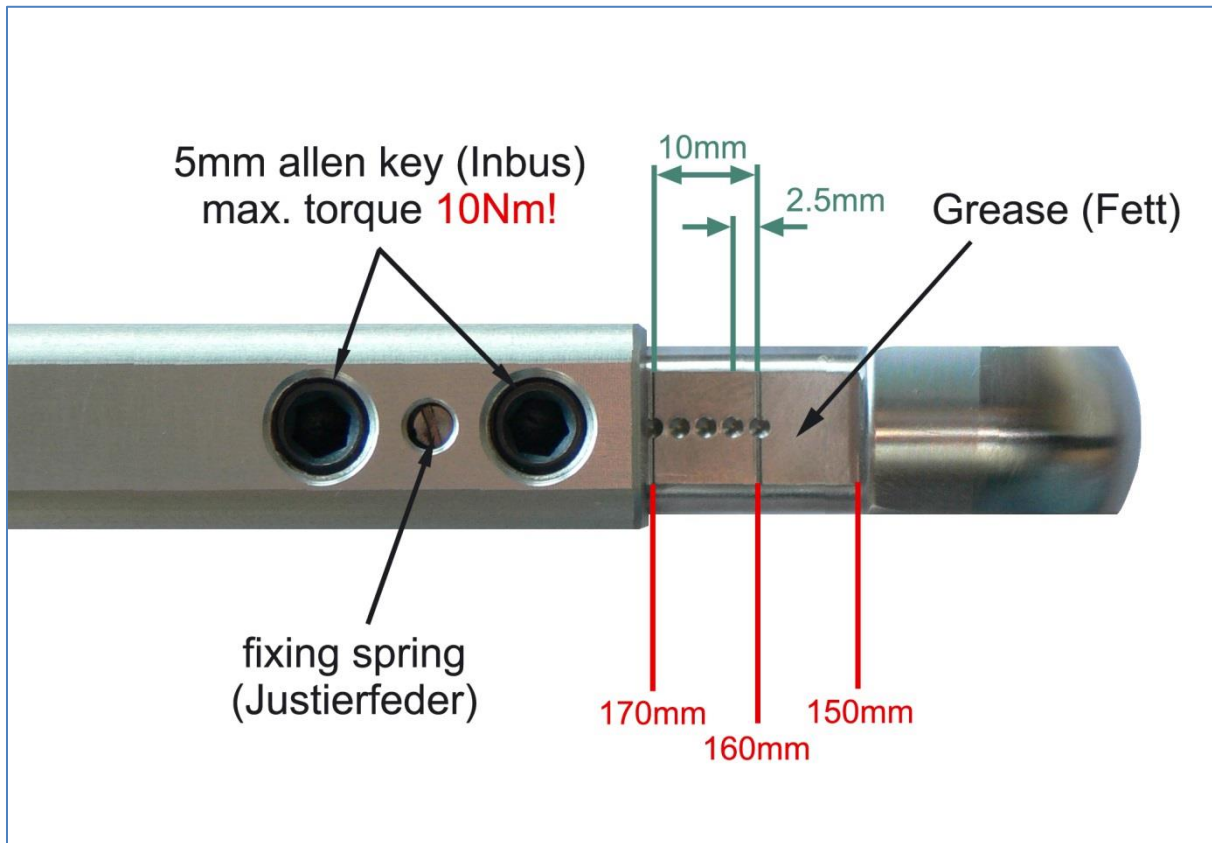

From time to time it is necessary to grease the steel elements of the crank to protect them from sweat and to maintain the free movement.

Mechanical adjustment & positioning of the athlete

Optimizing individual positioning is quickly achieved by adjusting the saddle and handlebar vertically and/or horizontally. To do so you have to open the locking lever. Because of a ruler which is attached to the saddle post you can reproduce your perfect positioning.

If adjusted correctly, it should be easy to move the vertical and horizontal stems when the quick release is open. A 5 mm Allen key situated on the saddle and handlebar mounts allows for further rigidity.

Horizontal & Vertical Positioning of the saddle

The ruler which is integrated in the seat stay gives you the distance between the center of the bottom bracket and the front of the saddle. The distance in cm can be read from the left hand side of the seat stay.



Horizontal / Vertical Positioning of the handlebars



Fly masses

The mass moment of inertia of a cycling athlete causes an approximate constant angular velocity of the pedaling circle, although the cyclist's torque (power) is nearly zero when the cranks are in vertical position. If the SRM Ergometer had no fly mass, the cadence would decrease to nearly zero in the vertical crank position and high power output, resulting in a non-circular pedal cadence. This would result in a very non-circular tread then. Therefore the SRM Ergometer is currently equipped with two fly masses: **SMALL (12mm thick, 4,6kg)** and **LARGE (24mm thick, 9,1kg)**.

Notice:

The default configuration for the most common Ergometer tests is installing the LARGE fly mass inside the gearbox on its own!

Please remove the SMALL fly mass as described below! For more information on kinetic energy simulation, fly masses and gear ratio of the Rohloff hub see the manual or visit our webpage at www.srm.de.

Removal and mounting instructions

Always disconnect the power supply from the Ergometer when opening the side covers! Never operate the Ergometer without the side covers! Before removing side covers insure fly masses have stopped spinning completely and use care when handling the fly masses to prevent injuries or bruises – both are very heavy!

- To remove/mount a fly mass you need the following tools: One or two aluminum spacer, Torx screwdriver and nut wrench (Fig.1)
- Open the cap of the Ergometer by removing the seven Torx screws (marked red) with the Torx T30 wrench (Fig.2)
- Use the nut wrench to rotate the brass nut counterclockwise (Fig.3). Hold the fly mass to counter the tool pressure if needed
- Remove the nut and pull the two fly masses off the axle (Fig.4). Pay attention not to damage the threads on the axle
- Replace the SMALL fly mass with one aluminum spacer (Fig.5) or add two spacers when replacing the LARGE fly mass. Make sure the groove in the spacer coincides with the feather key in the axle

Always insure the correct fly mass/spacer configuration: When installing both fly masses always add the SMALL fly mass first onto the axle. When removing the SMALL fly mass, add one spacer first, then add the LARGE flywheel. Same when replacing the LARGE fly mass – add the SMALL fly mass first and then add the two spacers. When testing without any fly mass remove all parts including the brass nut.

- To reinstall the fly mass on the axle (Fig.6) make sure the groove in the fly mass coincides with the feather key in the axle. This groove will lock the fly mass and prevent the fly mass from spinning free
- Using the nut wrench, rotate the brass nut clockwise until hand-tight (Fig.7)
- Make sure the fly mass sits firmly, has no play on the axle and can rotate freely! Remove all tools inside the gearbox! Reinstall the cover with the seven Torx head screws. Do not over tighten!

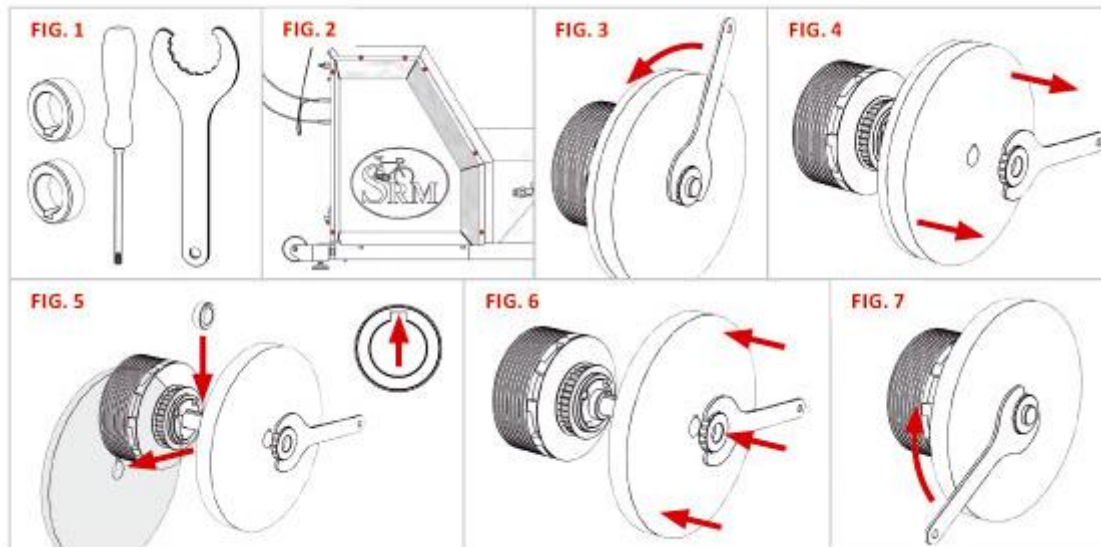

Version: V1.0 / June 2016 © 2016 SRM GmbH

All copyrights and trademarks are the property of their respective owners

Bike fitting

Transfer settings of client's own bike to the sitting position.

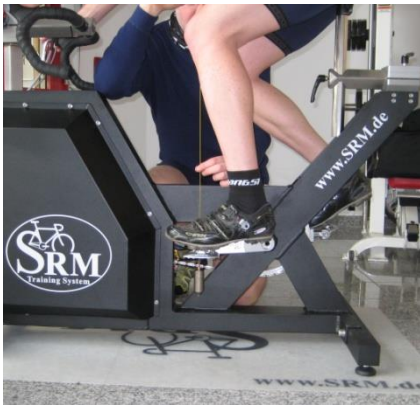
 A person is seated on an SRM ergometer. The image shows their right leg extended downwards, with the heel of their shoe touching the pedal. The ergometer frame has 'www.srm.de' printed on it.	<p>Saddle height</p> <p>The heel with the extended leg should reach the lowest position in the pedaling cycle.</p>
 A person is seated on an SRM ergometer. The image shows their right leg in a horizontal position, with the knee (patella) aligned vertically with the pedal axle. The ergometer frame has the SRM logo and 'www.srm.de' printed on it.	<p>Saddle setback</p> <p>In the horizontal position of the crank the knee (patella) should be perpendicular to the pedals axle.</p>

Rohloff gear check

We recommend to verify the gear of the Rohloff hub before every test or training. Our general recommendation is to use gear 9 - corresponding to the red point at the turning handle.

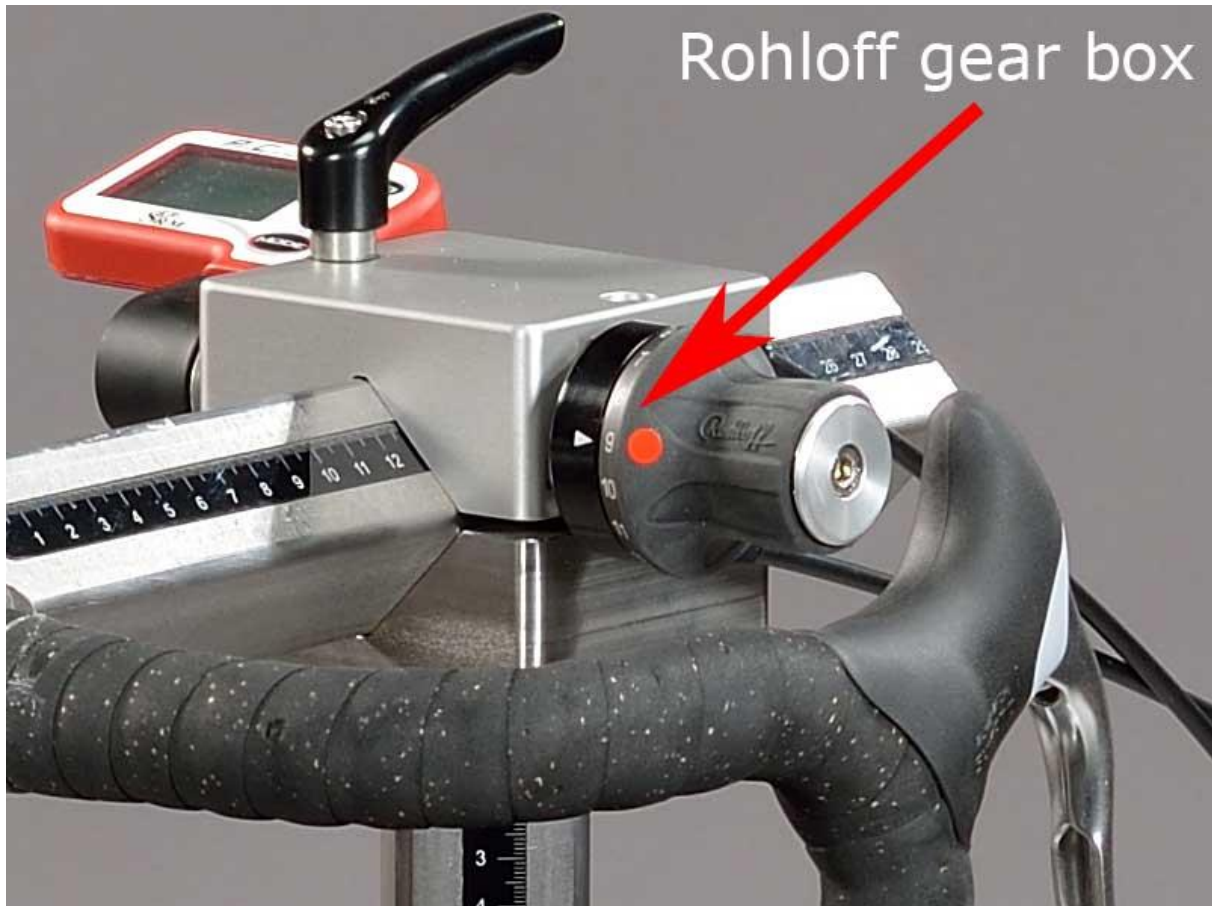

7. PowerControl Ergometer

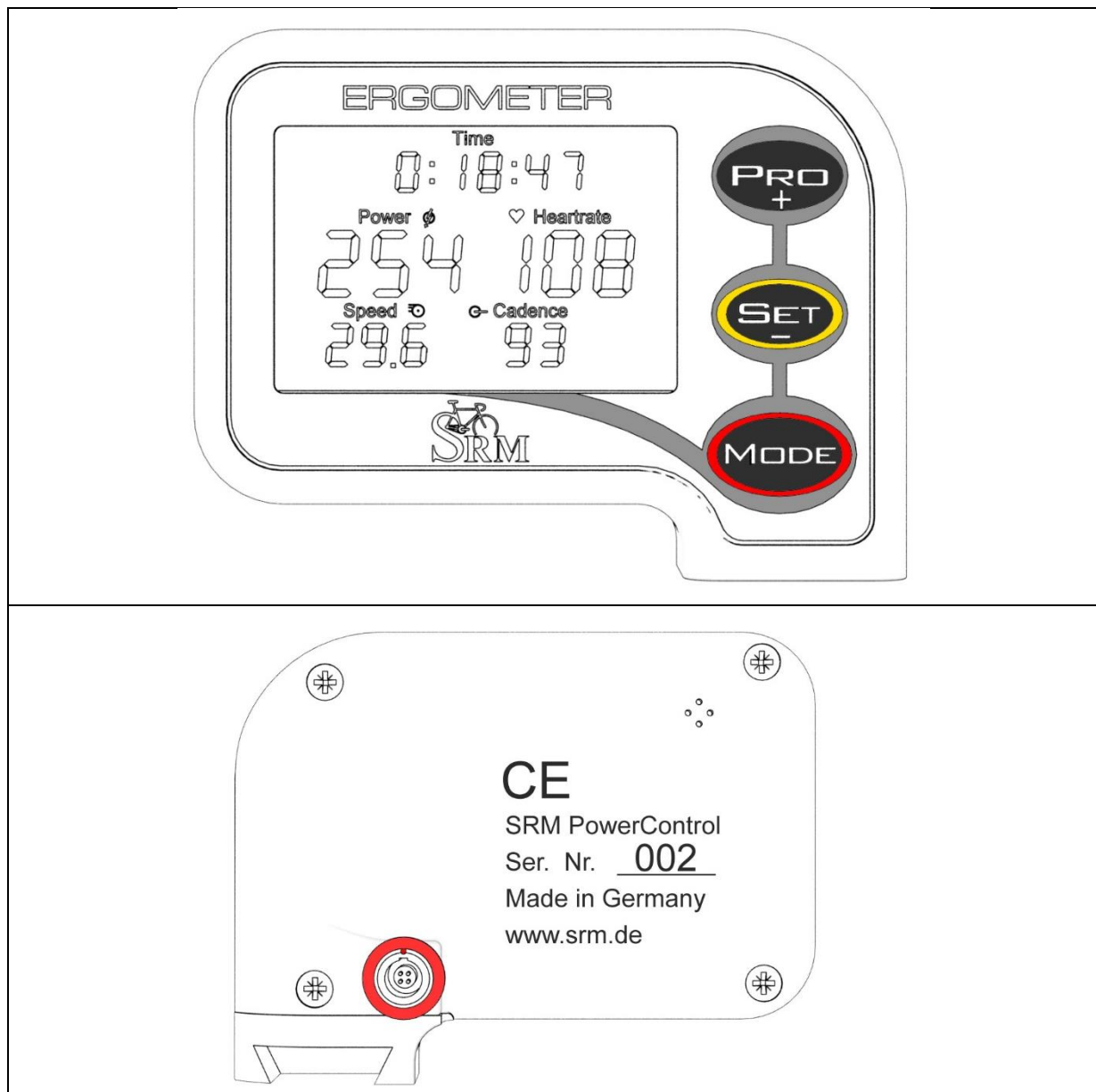

Main menu

The PowerControl Ergometer is the new version of the PowerControl and can be used only with the new ergometer control. It receives the heartrate data and displays the training time, power, heartrate, speed and cadence.

Real-time Training Data Menu:

- Top Line: Total training time.
- Middle Line: Power [Watt], Heartrate [bpm].
- Bottom Line: Speed [km/h], Cadence [rpm].

If no signal from a sensor is picked up, the display shows "-" for this data instead of a number (for example Heartrate "-" if the heartrate sensor is not paired).

Sensor Pairing

You need to pair the PowerControl (PC) Ergometer with the heartrate sensors. If you don't do this, no heartrate data will be received by the PowerControl Ergometer and can't be saved in the ergometer software.

Please follow these steps:

- Connect the ergometer to the power supply.
- Switch on heartrate sensor by putting the belt on your chest. Please moisten the electrodes to improve contact.
- Switch on the PowerControl by pressing the MODE and PRO buttons simultaneously.
- Select the heartrate sensor you like to pair: Possible heartrate sensors are SUUNTO or the PLUS (the PLUS-SRM heartrate sensor belongs to the ergometer standard accessory)
- Press SET for searching the heartrate sensor; the search bar of the display shows the progress of the search and the antenna symbol is flashing.
- If the heartrate sensor is found, the search bar is completed, the antenna symbol is displayed continuously and in the bottom line the sensor's serial number is displayed.
- Hold MODE for about 3 seconds to get back in the main display chart, the heartrate should be displayed after a short time.

If no signal is picked up, please check and repeat pairing from the beginning:

- Damp the heartrate belt at the skin sensors to ensure that the heartrate data can be recorded by the heartrate belt.
- If the sensor is working e.g. with another receiver (e.g. heartrate watch, PC8).
- Check the battery of the heartrate sensor.
- If it is still not working, please get in touch with the SRM Service Center.

When a sensor is found, the PowerControl will show "Found" in the top line, alternating with the sensor's serial number.

If the pairing fails, please repeat pairing from the beginning.

Control test with PowerControl keys

You have the possibility to start and stop the test (or the training session) with the keys of the PowerControl.

Keyboard Shortcuts:

- PRO (short): Test Start
- SET (short): Test Pause
- PRO (long): Test Resume
- SET (long): Test Stop

8. Workouts

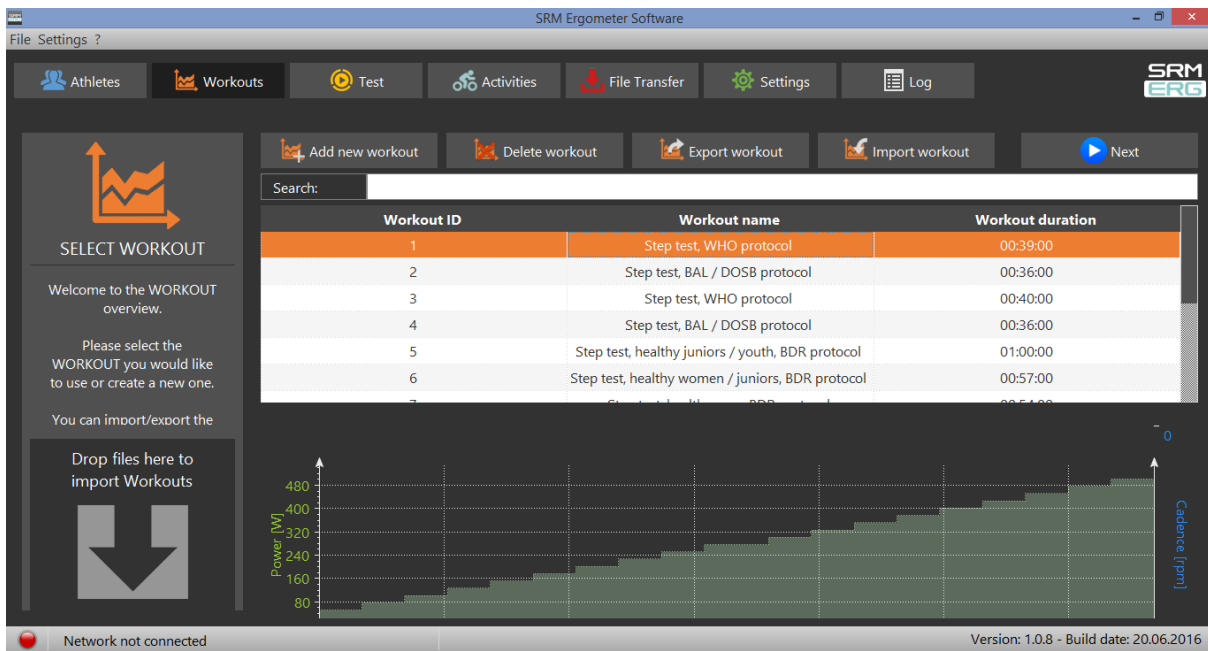

The “Workouts” tab allows you to add a new , delete, export or import a workout/protocol. So it is possible to import very easy a workout file

- Add new workout
- Import new workout
- Drop file to import workout

You can import new workouts as .erg files and as .fit files.

9. Test



Warm-up

We recommend to perform at least a warm-up time of 5-15 min with a low workload (e.g. 75-100W). Please note that the warm-up length and workload is dependent of the kind of test you like to perform with the athletes. Of course it is possible to create and to save different warm-up workouts (s. Workouts/ Add new workout).

Furthermore a warm-up is always a good opportunity to check the functions and the settings for Heart rate, Cadence, Power and Speed.

Start and Stop performance diagnostics

BRAKE ON: The brake is active and the client can pedaling with resistance

BRAKE OFF: The brake is deactivate and the client can continue pedaling without resistance and cool down – continuous recording of the heart rate

(No Brake or Brake on only works in combination with an Ergometer)

START: Start by beginning to pedal or pushing the Start Button (Check the values displayed on the computer screen)

STOP: Finish the test

PAUSE: Interrupt the test

NEXT STEP: Go to the next step of the test

LAST STEP: Go to the last step of the test

STOP ERGO: Stop the ergo immediately (it only works without cadence)



Next steps

- Comment: Entry file name then press Save
- Recommended cool – down - protocol with lower workload
- Clean the ergometer (!)



10. Activities



- Select activity to analyze, export or delete
- Export activity as .fit file, pdf, png, jpg
- Activity-ID is automatically generated

11. File Transfer

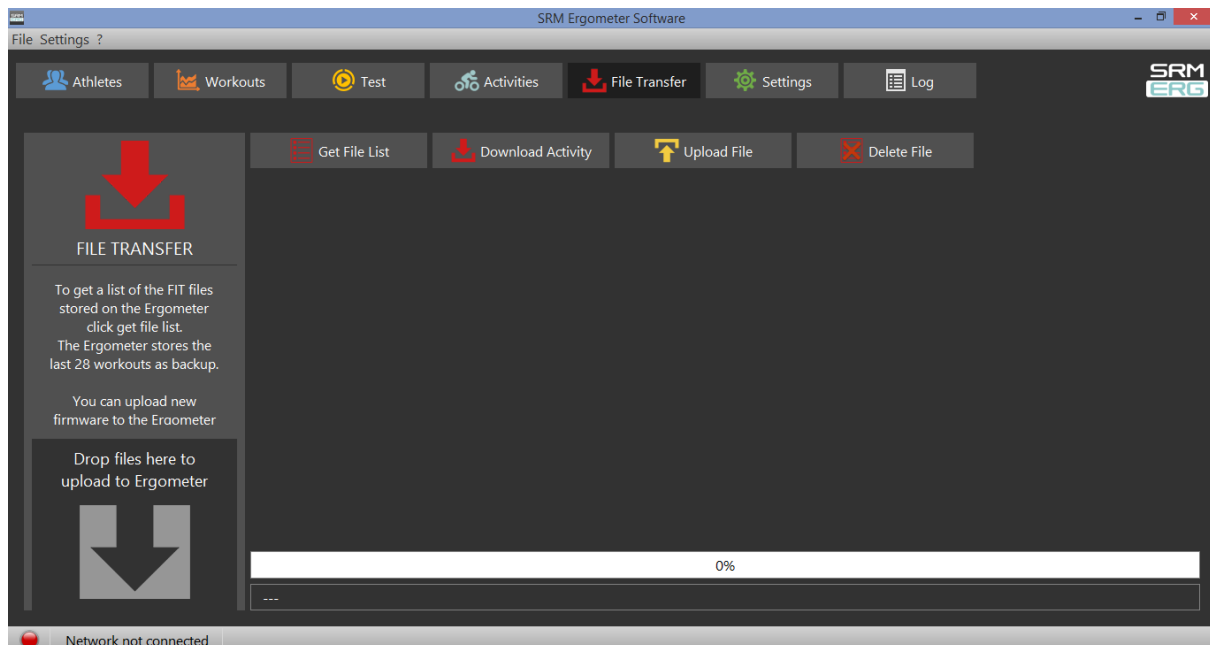

GET FILE LIST:

- Get a list of the FIT files
- Upload new files to the Ergometer or Download an activity
- The Ergometer stores the last 28 workouts as backup

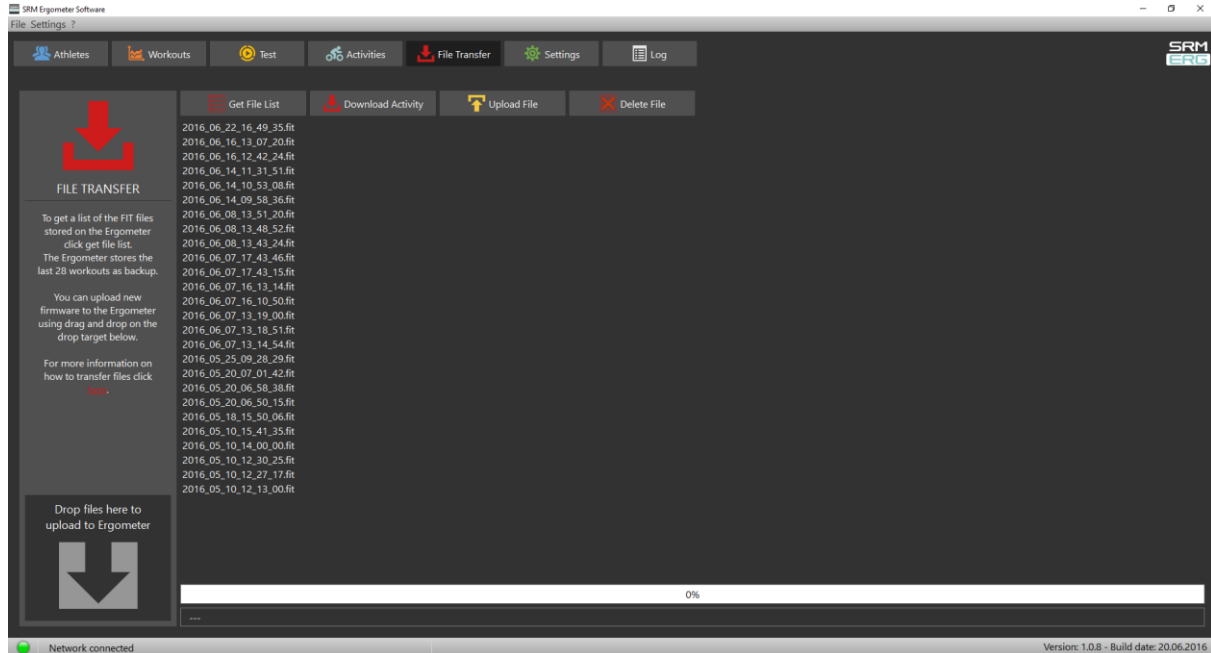

DOWNLOAD ACTIVITY:

- To determine the save location

UPLOAD FILE:

- You can upload new firmware to the Ergometer (.sfi files)

12. Service

Recommendation:

- crank: send in for service every two years
- ergometer: send in for service every four years

Contact person:

Mirco Smerecnik
Support SRM Ergometer

SRM GmbH
Rudolf-Schulten-Str. 6
52428 Jülich
Germany

Phone: +49 (0) 2461 / 69123-45

Fax: +49 (0) 2461 / 69123-17

eMail: mirco@srm.de

skype: [mirco.smerecnik](https://www.skype.com/user/mirco.smerecnik)

www.srm.de